

VENTO ECO2 A50 Pro

HEAT RECOVERY SINGLE-ROOM UNITS

Features

- Arrangement of efficient energy-saving supply and exhaust single-room ventilation in flats, houses, cottages, social and commercial premises.
- Air purification with optional F8 filter PM2.5 99 %.
- Protection from outdoor noise.
- Reducing heat losses caused by ventilation due to heat recovery.
- Humidity balance and regulated air exchange create individually controlled microclimate.



Air flow:
up to 50 m³/h
14 l/s



Heat recovery efficiency:
up to 92 %



Power:
from 2.07 W



Noise level:
from 13 dBA



Design

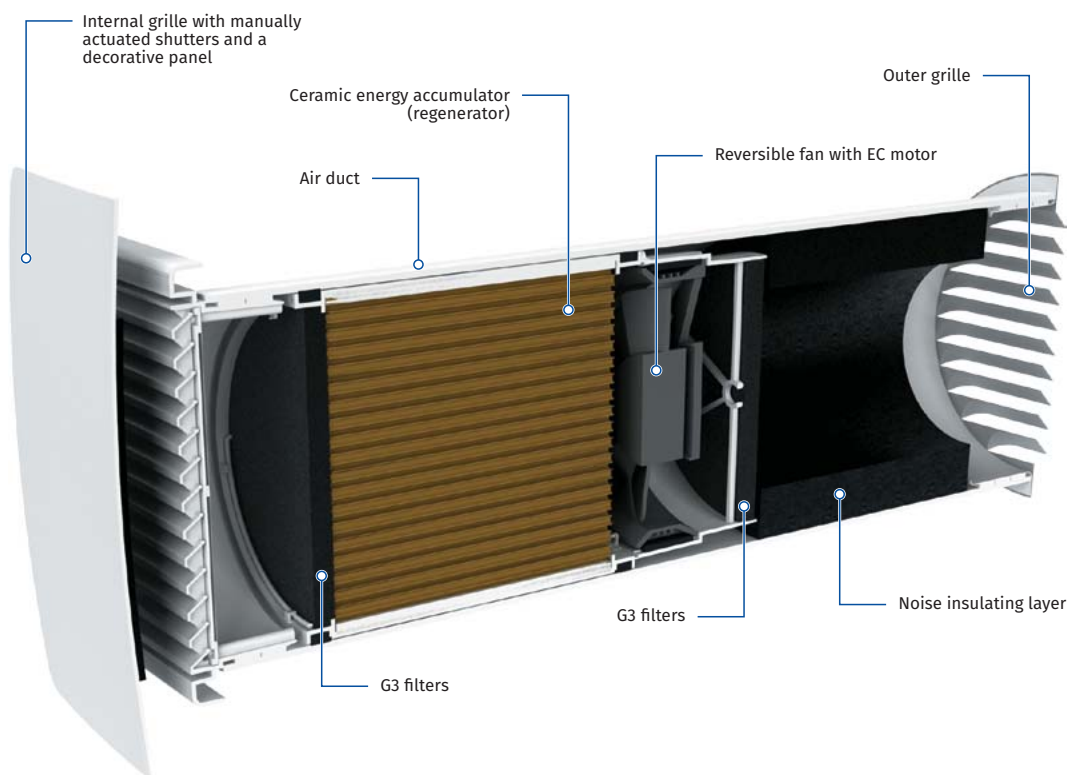

Designation key

Model	Number of units, items	Air duct	Nominal air flow [m ³ /h]	Hood type	Control
VENTO Eco	2	A: round air duct	50	S1: round metal grille S9: round plastic grille S: metal hood for thin walls	Pro: sensor control panel

VENTO ECO2 A50 Pro

HEAT RECOVERY SINGLE-ROOM UNITS

Heat and moisture regeneration

UNIT OPERATING LOGIC IN WINTER PERIOD

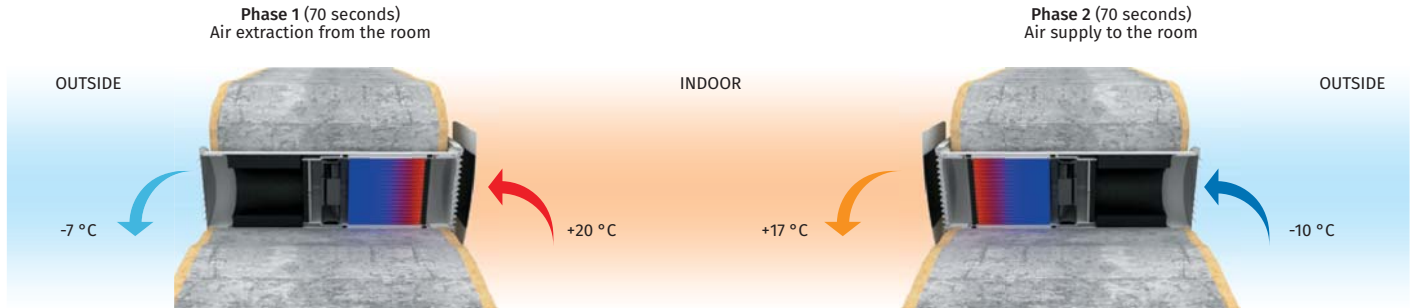

- Warm stale air is extracted from the premise, flows through the ceramic regenerator and transfers its heat energy and moisture to it.
- As the ceramic regenerator gets warmed up, the unit switches to the supply mode.
- Clean cold intake air flows through the regenerator and absorbs accumulated heat and humidity.
- When the ceramic regenerator is cooled down, the unit switches to the extract air mode.

Control

- Control of the unit operation mode is performed by means of sensor control panel located on the unit casing or a remote controller.

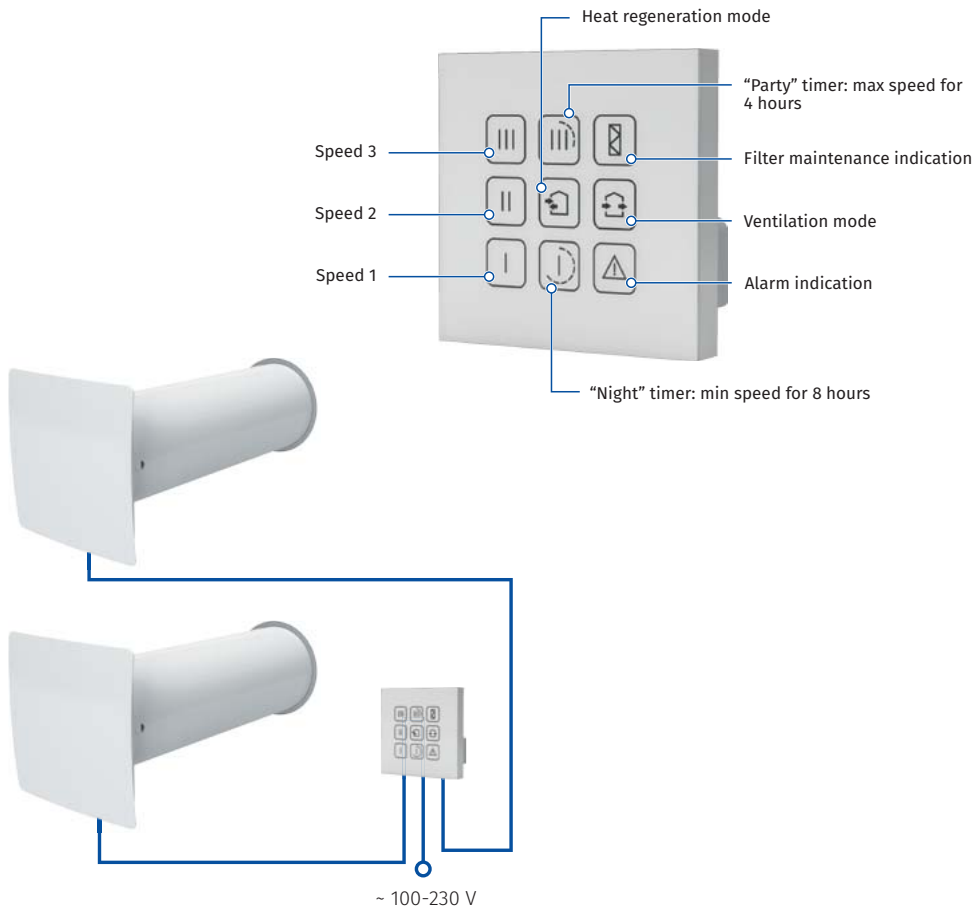

- Low voltage (12 V) power supply between control panel and VENTO Eco2 units.

VENTO ECO2 A50 Pro

HEAT RECOVERY SINGLE-ROOM UNITS

Mounting

- The unit is designed for through-the-wall installation inside a prepared hole in an outer wall of the building.
- VENTO Eco2 A50 S1 allows arranging the most efficient balanced ventilation. Two units, connected to single control panel, operate in reverse phases. One unit ensures supply of fresh air to the room and the

- other unit provides air extract from the premise. In regeneration mode units change direction of air flow to opposite one every 70 seconds.
- One unit is able to ventilate a room up to 25 m². For bigger rooms two or more units must be installed.

VENTO ECO2 A50 S1(S9) PRO

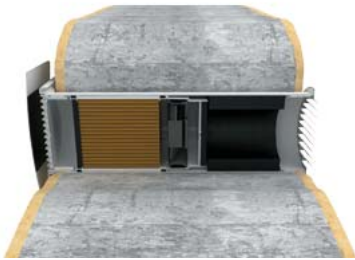

VENTO ECO2 A50 S Pro

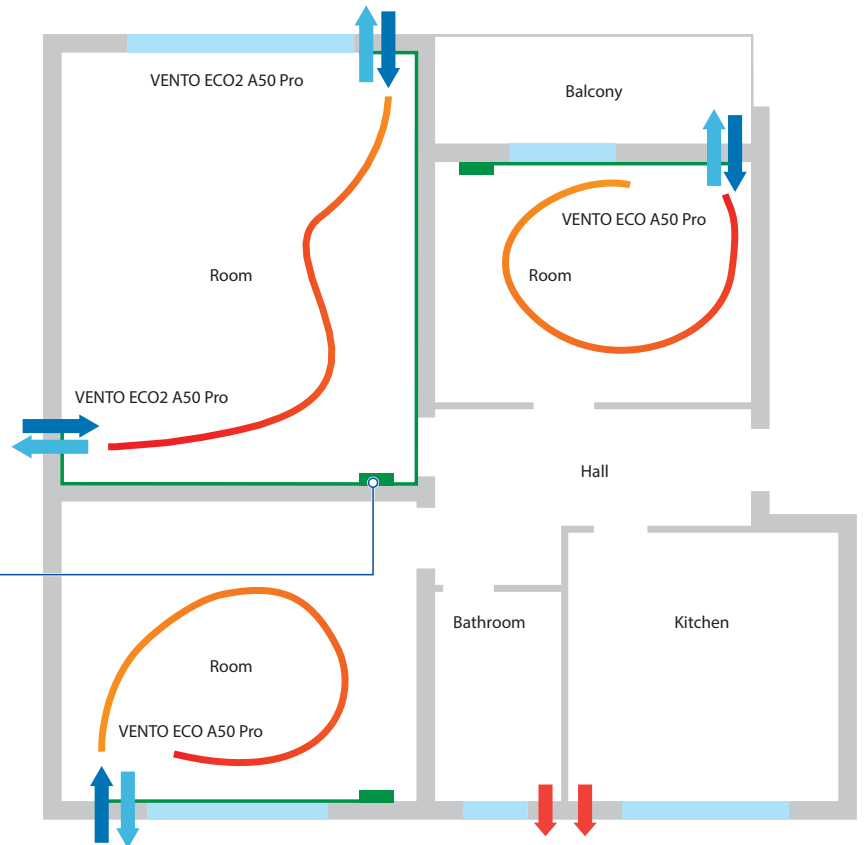

Overall dimensions [mm]

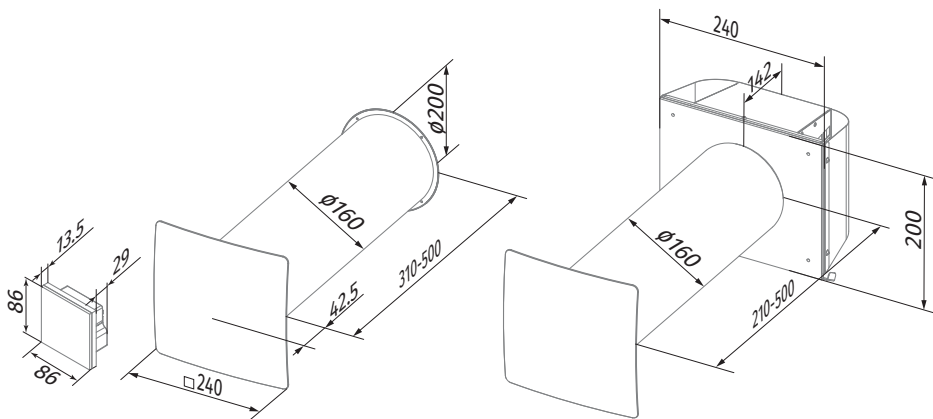

VENTO ECO2 A50 S1(S9) Pro

VENTO ECO2 A50 S Pro

VENTO ECO2 A50 Pro

HEAT RECOVERY SINGLE-ROOM UNITS







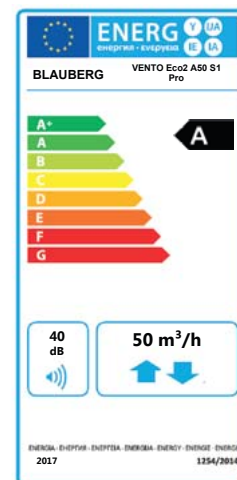







Technical data

Parameters	VENTO ECO2 A50 Pro		
	I	II	III
Speed			
Voltage [V / 50 (60) Hz]		100-230	
Power [W]	2.07	4.15	10.10
Current [A]	0.030	0.049	0.098
RPM [min ⁻¹]	1030	1760	2690
Air flow in ventilation mode [m ³ /h]	15 (4)	30 (8)	50 (14)
Air flow in heat recovery mode [m ³ /h]	15 (4)	30 (8)	50 (14)
Filter	G3 (option: F8 PM2,5 > 99 %*)		
Transported air temperature [°C]	-20...+50		
Sound pressure level at 1 m [dBA] In accordance with ISO 3741: 2004	22	29	32
Sound pressure level at 3 m [dBA] In accordance with ISO 3741: 2004	13	20	23
Outdoor sound pressure attenuation [dBA] according to DIN EN 20140	41		
Regeneration efficiency [%] In accordance with DIBt LÜ-A 20	up to 92		
SEC Class	A		
Ingress protection rating	IP24		

* maximum air flow 40 m³/h



Accessories

Name	Description
Completion Kit VENTO Eco A50	 Cartridge with heat regenerator, fan and G3 filters. Square and round indoor grille with manually actuated shutters
SE VENTO Eco A50 Pro	 Sensor control panel (white)
SE VENTO Eco A50 Pro black	 Sensor control panel (black)
R 160-500	 500 mm air duct and plastic foam plug
R 160-700	 700 mm air duct and plastic foam plug
AH chrome 160	 Outer hood made of brushed stainless steel
AH-S chrome 160	 Outer hood for thin wall made of brushed stainless steel
Decor 150Fs An white	 Outer grille
KIT BlauPlast white 160	 Kit for angular mounting with white outer grille
KIT BlauPlast chrome 160	 Kit for angular mounting with stainless stees outer grille
FP VENTO Eco A50 G3	 G3 filters (2 pcs.)
FP VENTO Eco A50 F8	 G2 + F8 filters (1 pc.). Filtration rate PM2.5 99 %. Combination of G2 + F8 filters reduces air flow down to 40 m ³ /h
L VENTO Eco A50	 Fan
PP 160	 Plastic outer grille with pipe for mounting from indoor